



## KR 12 R750 Z340 CR



Designation	KR 12 R750 Z340 CR
Number of axes	4
Pose repeatability XY	± 0.025 mm
Pose repeatability Z	± 0.005 mm
Pose repeatability R	± 0.005 °
Weight	approx. 52 kg
Rated payload	6 kg
Maximum payload	12 kg
Maximum reach	750 mm
Mounting position	Floor
Footprint	210 mm x 210 mm

### Axis data

Motion range	
Motion range, axis 1	±145 °
Motion range, axis 2	±145 °
Motion range, axis 3	-340 mm / 1 mm
Motion range, axis 4	±355 °
Speed with rated payload	
Axis velocity, axis 1	425 °/s
Axis velocity, axis 2	655 °/s
Axis velocity, axis 3	1.1 m/s
Axis velocity, axis 4	2700 °/s

### Operating conditions

Ambient temperature during operation: 0 °C to 42 °C (273 K to 315 K)

### Protection rating

Protection rating (IEC 60529) IP54

### Controller

Controller KR C5 micro

### Certificates

ESD requirements IEC61340-5-1; ANSI/ESD S20.20  
 Certificates CE/UL

### Workspace graphic

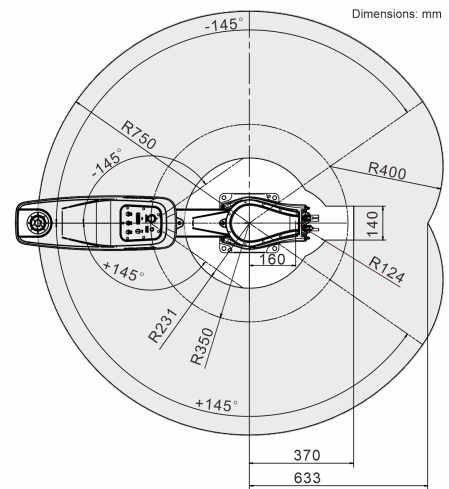

### Payload diagram

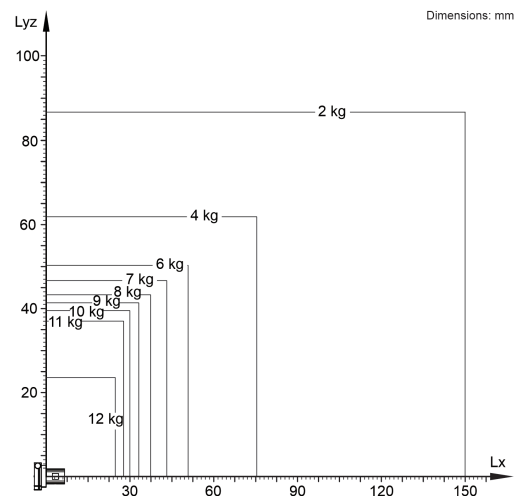

The KR 12 R750 Z340 CR is designed for a rated payload of 6 kg in order to optimize the dynamic performance of the manipulator. With the reduced load center distances, higher loads up to the maximum payload may be used. The specific load case must be verified using KUKA.Load. For further consultation, please contact KUKA Support.

### Cycle time

0.43 s (25 mm / 300 mm / 25 mm, 2 kg)

